

Assembly Instructions

KETTLER

Harlow Carr Dining Chair

0797311-4470



IMPORTANT

PLEASE KEEP THIS BOOKLET FOR FUTURE REFERENCE.
THIS IS IMPORTANT INFORMATION REGARDING THE USE AND
CARE OF YOUR GARDEN FURNITURE.

Maintenance and Care Instructions



No assembly required for this product

- This product may only be used for its intended purpose for residential premises.
- Kettler furniture is designed to be left outdoors all year round (excluding cushions). Cushions should be stored in a dry ambient temperature when not in use.
- Kettler cushions are not suitable for dry cleaning and are not machine washable. Sponge clean only.
- We recommend you clean your Kettler furniture at the beginning and end of the season.
- To clean your Kettler furniture, use warm soapy water only. Never use abrasive chemicals or cleaning agents. Tree sap and bird droppings should be cleaned off immediately.
- Moving parts such as locking mechanisms, catches and joints need to be lubricated where necessary.
- Kettler furniture can be covered – we recommend that you only use Kettler tailored covers (where available).
- This product is 100% recyclable. At the end of the products life, please dispose of responsibly.
- Colours may vary slightly.



Attention

Please be aware that painted/varnished surfaces can be damaged by sunscreens and oil based products. If the surface of your Kettler leisure furniture comes into contact with sunscreens, the surface is to be cleaned without delay as described above. Only in this way can lasting discolouration of the surface by the ingredients of the sunscreen be prevented.

Spare Parts

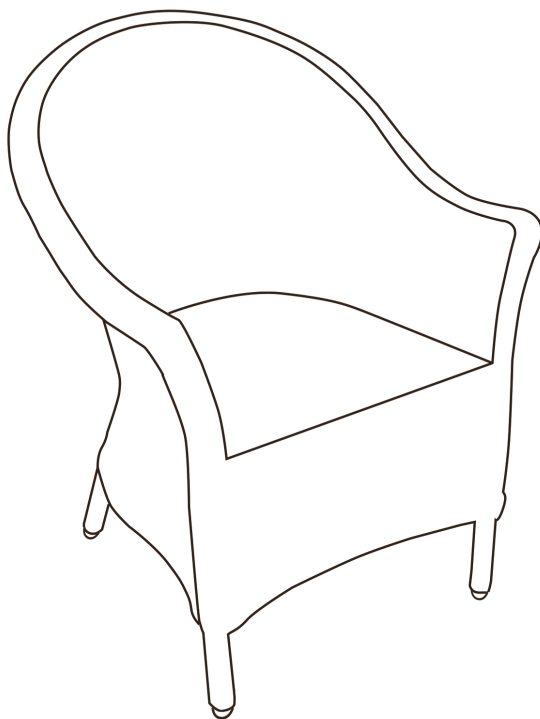

Foot Caps
SPGFC-0797311



For further information and spare parts visit our website www.kettler.co.uk/shop

For Your Safety

- This product may only be used for its intended purpose as furniture for residential properties.
- Check all components regularly for correct function, damage and loose connections especially at the start of the season and at 1-2 month intervals dependent on use.
- Damaged components may endanger your safety or shorten the life of the product. Replace all damaged parts immediately. Use only spare parts manufactured by Kettler. Should you wish to purchase spare parts, they can be ordered directly from: www.kettler.co.uk/shop
- Kettler will not be responsible for damaged caused by improper use.



Attention

- Whilst assembling this product keep out of the reach of children. (Choking hazard – contains small parts)
- Ensure that your working area is free of possible sources of danger, for example don't leave any tools lying around.
- Always dispose of packaging material in such a way that it may not cause any danger. There is always a risk of suffocation if children play with plastic bags!
- We reserve the right to make changes for technical reasons.

KETTLER

Kettler GB Limited,
Merse Road, North Moons Moat,
Redditch, Worcestershire,
B98 9HL



www.kettler.co.uk



Warranty For Home Use

This product is covered by a 3 year warranty against manufacturing faults. This warranty applies to domestic use only. It does not cover commercial use, mis-use or accidental damage.

To validate your warranty, register at www.kettler.co.uk and quote the product code from the front of this booklet.

KETTLER

Harlow Carr 70cm Bistro Table









0797312-4470

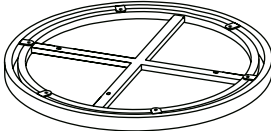

IMPORTANT

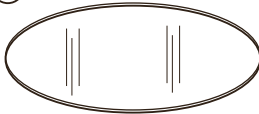
PLEASE KEEP THIS BOOKLET FOR FUTURE REFERENCE.
THIS IS IMPORTANT INFORMATION REGARDING THE USE AND
CARE OF YOUR GARDEN FURNITURE.

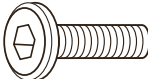
Parts List

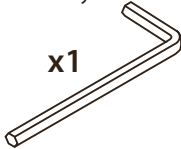
<p>(A) Table Top</p>  <p>x1</p>	<p>(B) Table Leg</p>  <p>x2</p>	<p></p> <p>Do not discard any of the packaging until you have checked that you have all the parts and the pack of fixings.</p>
<p>(C) Table side frame</p>  <p>x2</p>	<p>(D) Glass Top</p>  <p>x1</p>	<p>(E) Plastic Caps</p>  <p>x12</p>
<p>(F) Screws M6x40</p>  <p>x12</p>	<p>(G) M6 Steel Washers</p>  <p>x12</p>	<p>(H) Allen Key</p>  <p>x1</p>

Helpful advice before you begin:

1. We suggest you spend a short time reading through this leaflet and then follow the simple step by step instructions.
2. Do not discard any of the packaging until you have checked that you have all the parts and the pack of fittings.
3. Assemble this product on a soft surface.
4. To ensure an easier assembly, we strongly advise that all fittings are only finger tightened during initial assembly. Only upon completion of the assembly should all fixing points be fully tightened.
5. Keep fittings out of children's reach.
6. Do not use any other tools other than those recommended to build this product.
7. Please do not use substitute parts. Use only additional or replacement parts supplied by Kettler.
8. In the unlikely event that this product has missing or damaged parts, please visit our website www.kettler.co.uk/shop.

Assembly

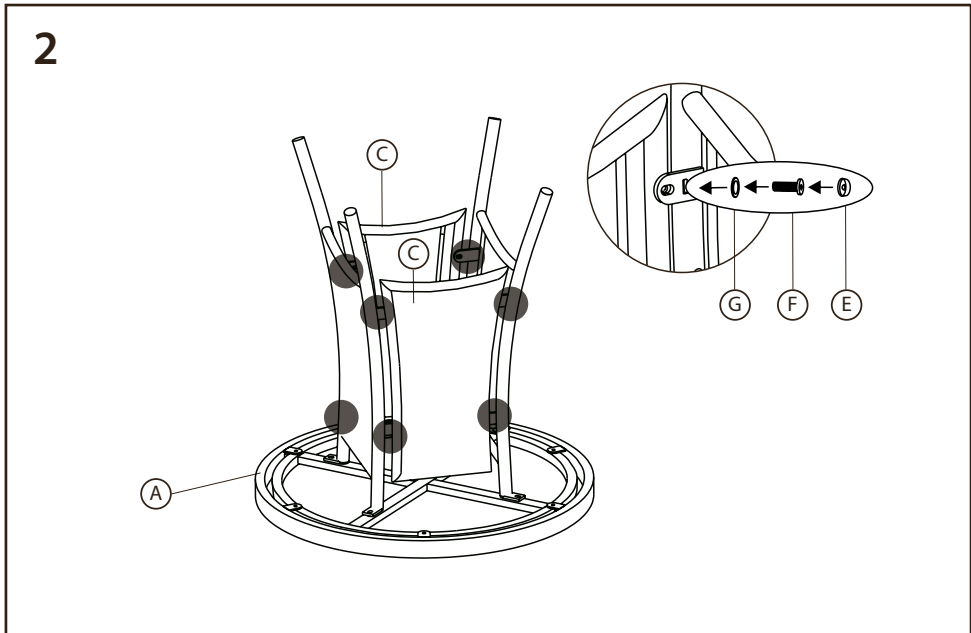
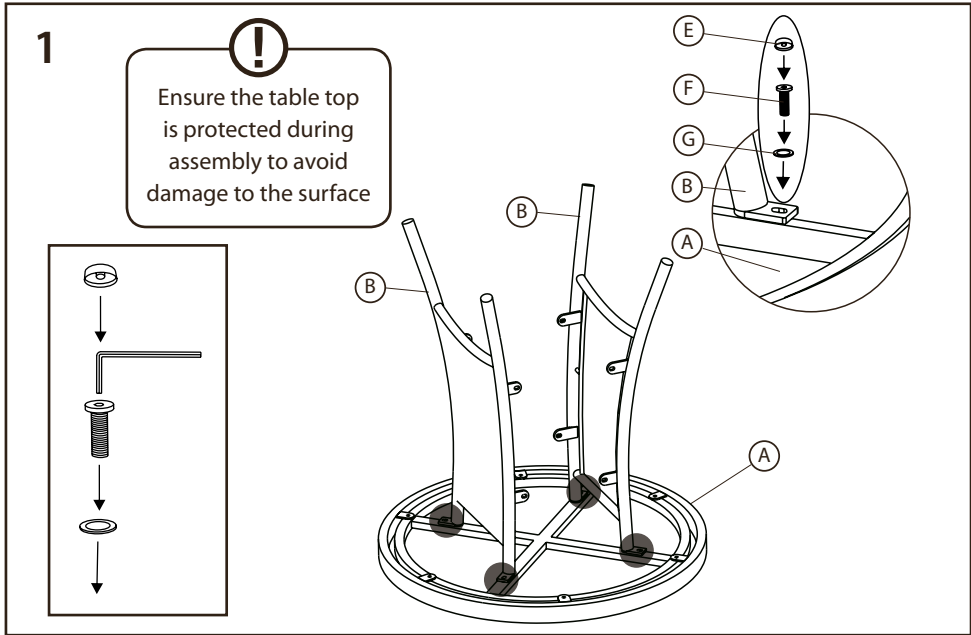

Assembly

3

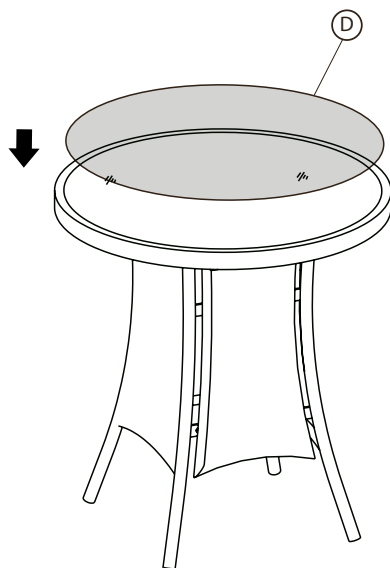

Assemble all parts
loosely and when all
components are in place
tighten fixings to secure

Maintenance and Care Instructions

- The table top is made from toughened glass and conforms to the UK BS standard. We recommend that you follow these simple tips and instructions to ensure it retains its good looks.
- This product may only be used for its intended purpose for residential premises.
- Kettler furniture is designed to be left outdoors all year round (excluding cushions).
- We recommend you clean your Kettler furniture at the beginning and end of the season.
- To clean your Kettler furniture, wash only with warm water and mild detergent. Do not use abrasive cleaners. Spray cleaners can and will cause the table to dis-colour.
- Remove food and drink residue, tree sap and bird droppings as soon as possible to avoid staining. Marks should be removed using neat mild detergent with a soft cloth and washed off with water.
- Do not leave hot items directly on the table. Coasters will protect your table from heat and water rings.
- Do not drop anything sharp or heavy onto the table.
- Take care when placing items onto the table to avoid scratches.
- Moving parts such as locking mechanisms, catches and joints need to be lubricated where necessary.
- Kettler furniture can be covered – we recommend that you only use Kettler tailored covers (where available).
- This product is 100% recyclable. At the end of the products life, please dispose of responsibly.
- Colours may vary slightly.



Attention

Please be aware that painted/varnished surfaces can be damaged by sunscreens and oil based products. If the surface of your Kettler leisure furniture comes into contact with sunscreens, the surface is to be cleaned without delay as described above.

Only in this way can lasting discolouration of the surface by the ingredients of the sunscreen be prevented.

Spare Parts

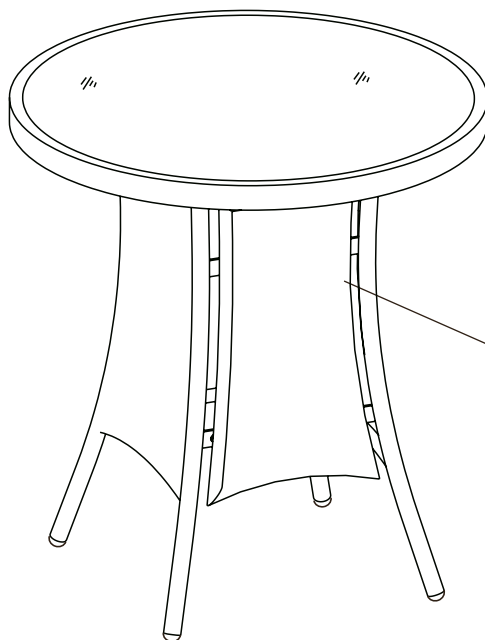

Bolt Pack
SPGBP-0797312

Foot Caps
SPGFC-0797312



For further information and spare parts visit our website www.kettler.co.uk/shop



For Your Safety

- This product may only be used for its intended purpose as furniture for residential properties.
- Check all components regularly for correct function, damage and loose connections especially at the start of the season and at 1-2 month intervals dependent on use.
- Damaged components may endanger your safety or shorten the life of the product. Replace all damaged parts immediately. Use only spare parts manufactured by Kettler. Should you wish to purchase spare parts, they can be ordered directly from: www.kettler.co.uk/shop
- Kettler will not be responsible for damaged caused by improper use.



Attention

- Whilst assembling this product keep out of the reach of children. (Choking hazard – contains small parts)
- Ensure that your working area is free of possible sources of danger, for example don't leave any tools lying around.
- Always dispose of packaging material in such a way that it may not cause any danger. There is always a risk of suffocation if children play with plastic bags!
- We reserve the right to make changes for technical reasons.

KETTLER

Kettler GB Limited,
Merse Road, North Moons Moat,
Redditch, Worcestershire,
B98 9HL



www.kettler.co.uk



Warranty For Home Use

This product is covered by a 3 year warranty against manufacturing faults. This warranty applies to domestic use only. It does not cover commercial use, mis-use or accidental damage.

To validate your warranty, register at www.kettler.co.uk and quote the product code from the front of this booklet.